

**FOTOCPELLULE CILINDRICHE M18
TASTEGGIO DIRETTO**

SERIE OCV81/D *SERIES*

***M18 PHOTOELECTRIC CYLINDRICAL
SENSORS DIFFUSE TYPE***

FOTOCELLE CILINDRICHE M18 - TASTEGGIO DIRETTO
M18 CYLINDRICAL PHOTOELECTRIC SENSORS - DIFFUSE TYPE



FOTOCELLE STANDARD M18 A TASTEGGIO DIRETTO, CON TESTINA A 90° E FREQUENZA DI LAVORO 10 kHz
VERSIONI A 100, 200, 400, 600, 1000 mm DI PORTATA. USCITA CAVO O CONNETTORE M12. CONTENITORE PLASTICO O METALLICO.

STANDARD M18 PHOTOELECTRIC SENSORS DIFFUSE TYPE, WITH RADIAL CYLINDRICAL HOUSING AND 10 kHz WORKING FREQUENCY. SENSING DISTANCE VERSIONS 100, 200, 400 & 600, 1000 mm. CABLE OUT OR M12 PLUG-IN CONNECTOR. PLASTIC OR METAL BODY

COME ORDINARE
HOW TO ORDER

OCV81 - / D1 A P NO R M C5

VERSIONE/ VERSION

- = Versione standard
Standard version
- *K = Versione ad alte frequenze 10 kHz
High frequency 10 kHz version

* SOLO VERSIONI D e D1

SERIE/ SERIES

- D = Tasteggio diretto/ Diffuse type 100 mm
- D1 = Tasteggio diretto/ Diffuse type 200 mm
- D2 = Tasteggio diretto/ Diffuse type 400 mm
- D3 = Tasteggio diretto/ Diffuse type 600 mm
- D4 = Tasteggio diretto/ Diffuse type 1000 mm

TIPO DI OTTICA/ OPTICAL TYPE

- = Ottica assiale/ Assial optical
- §A = Ottica radiale/ Radial optical

§ SALVO VERSIONI D4

ELETTRONICA/ ELECTRONICS

- P = PNP (Vcc/Vdc)
- N = NPN (Vcc/Vdc)
- @C3 = Vca / Vac

@ SALVO VERSIONI K, D3 e D4

CONNESSIONE LINK

- = Cavo (2m)
Cable (2m)
- Kx = Metraggio cavo a richiesta
Cable lenght upon request
- KR = Uscita cavo 90°
90 degrees angled cable output
- C5 = Connettore M12
M12 Connector

MATERIALE CORPO BODY MATERIAL

- = Plastico/ Plastic
- M = Metallico/ Metal

SENSIBILITA'/ SENSITIVITY

- = Fissa/ Fixed
- R = Regolabile/ Adjustment

USCITA/ OUTPUT

- NO = Normalmente aperta (impulso luce)
Normally open (light on)
- NC = Normalmente chiusa (impulso buio)
Normally closed (dark-on)
- #SC = NO/NC selezionabile (3 Fili)
NO/NC programmable (3 Wires)
- #SC4 = 2 uscite, NO+NC (4 Fili)
2 outputs, NO +NC (4 Wires)

SALVO VERSIONI K

CARATTERISTICHE ELETTRICHE
GENERALI/ GENERALS
ELECTRICAL FEATURES
VERSIONE IN C.C.
D.C. TYPE

ALIMENTAZIONE	10 ÷ 30 Vdc	SUPPLY VOLTAGE
ONDULAZIONE RESIDUA	≤ 10%	RIPPLE
ASSORBIMENTO	< 25 mA	POWER CONSUMPTION
CARICO MASSIMO	250 mA	MAXIMUM LOAD
CADUTA DI TENSIONE	< 2V @ 200 mA	VOLTAGE DROP
PROTEZIONE C.C.	SI / YES	SHORT CIRCUIT PROTECTION
PROTEZIONE INVERSIONE DI POLARITA'	SI / YES	POLARITY REVERSAL PROTECTION
COMPATIBILITA' ELETTROMAGNETICA CE	EN 60947-5-2	CE COMPLIANCE

VERSIONE IN A.C.
A.C. TYPE

ALIMENTAZIONE	20 ÷ 230 Vac	SUPPLY VOLTAGE
ASSORBIMENTO	< 4 mA	POWER CONSUMPTION
CARICO MASSIMO	300 mA	MAXIMUM LOAD
CADUTA DI TENSIONE	< 3 V	VOLTAGE DROP
COMPATIBILITA' ELETTROMAGNETICA CE	EN 60947-5-2	CE COMPLIANCE

CARATTERISTICHE TECNICHE
TASTEGGIO DIRETTO/ DIFFUSE TYPE
TECHNICAL FEATURES

MODELLO	FISSO	D	DA	D1	D1A	D2	D2A	D3	D3A	D4	FIXED	MODEL
	REG.	-	-	D1...R	D1A...R	D2...R	D2A...R	D3...R	D3A...R	D4...R	ADJ.	
DISTANZA DI RILEVAMENTO (mm)		100*		200*		400**		600**		1000**		SENSING DISTANCE (mm)
		-		1 ÷ 200		1 ÷ 400		1 ÷ 600		1 ÷ 1000		
TIPO DI EMISSIONE	IR MODULATO 880 nm - PULSED IR 880 nm											EMISSION TYPE
FREQUENZA DI COMMUTAZIONE MASSIMA	(C.C.) 150 Hz (D.C.)											MAXIMUM OPERATING FREQUENCY
	(C.A.) 15 Hz (A.C.)											
TEMPERATURA DI LAVORO	-10°C ÷ 50°C											WORKING TEMPERATURE
TEMPERATURA DI STOCCAGGIO	-25°C ÷ 70°C											STOCK TEMPERATURE
MATERIALE CORPO PLASTICO	ABS											PLASTIC BODY MATERIAL
MATERIALE CORPO METALLICO	OTTONE NICHELATO / NICHEL PLATED BRASS											METAL BODY MATERIAL
MATERIALE LENTI	PMMA											LENSES MATERIAL
GRADO DI PROTEZIONE	IP65											IP RATING

CARATTERISTICHE TECNICHE TASTEGGIO DIRETTO 10 kHz/ 10 kHz DIFFUSE TYPE TECHNICAL FEATURES

MODELLO	FISSO	D	DA	D1	D1A	FIXED	MODEL
	REG	-	-	D1...R	D1A...R	ADJ.	
DISTANZA DI RILEVAMENTO (mm)	FISSO	100*		200*		FIXED	SENSING DISTANCE (mm)
	REG	-		2 ÷ 200		ADJ.	
EMISSIONE	IR MODULATO 880 nm - PULSED IR 880 nm						EMISSION
FREQUENZA DI COMMUTAZIONE MASSIMA	10 kHz						MAXIMUM WORKING FREQUENCY
TEMPERATURA DI LAVORO	-10°C ÷ 50°C						WORKING TEMPERATURE
TEMPERATURA DI STOCCAGGIO	-25°C ÷ 70°C						STORAGE TEMPERATURE
MATERIALE CORPO PLASTICO	ABS						PLASTIC BODY MATERIAL
MATERIALE CORPO METALLICO	OTTONE NICHELATO / NICHEL PLATED BRASS						METAL BODY MATERIAL
MATERIALE LENTI	PMMA						LENSES MATERIAL
GRADO DI PROTEZIONE	IP66						PROTECTION RATING

* PORTATA DEFINITA SU CARTA BIANCA CON RIFLESSIONE DEL 90% DIMENSIONI 100 x 100 mm
SENSING DISTANCE DEFINED ON WHITE PAPER WITH 90% REFLEX DIMENSIONS 100 x 100 mm

** PORTATA DEFINITA SU CARTA BIANCA CON RIFLESSIONE DEL 90% DIMENSIONI 200 x 200 mm
SENSING DISTANCE DEFINED ON WHITE PAPER WITH 90% REFLEX DIMENSIONS 200 x 200 mm

File Name: ocv81d.cdr
Rev: 0.1

La Ditta costruttrice si riserva di apportare qualunque modifica ritenga utile senza preavviso.
Manufacturer reserve itself all the rights to change without notice.

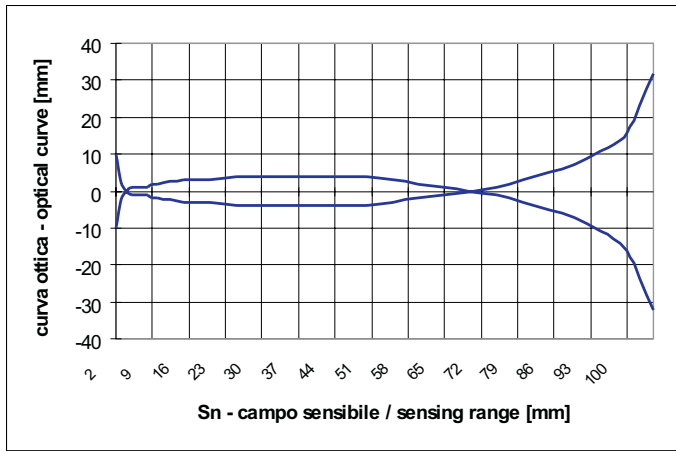
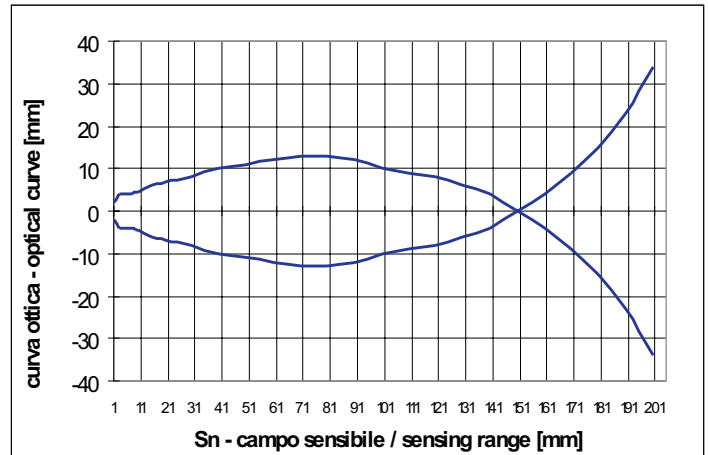
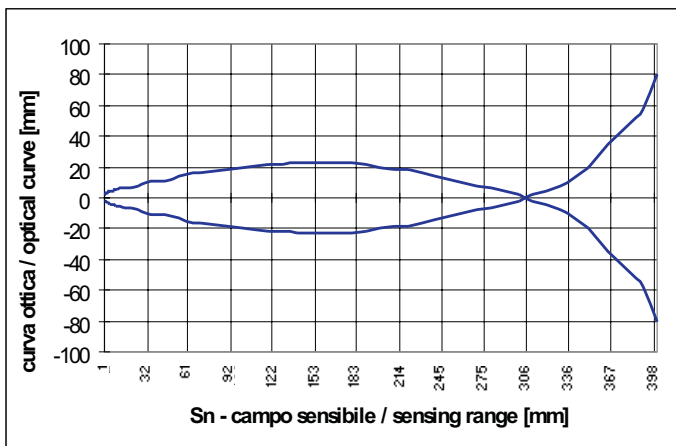
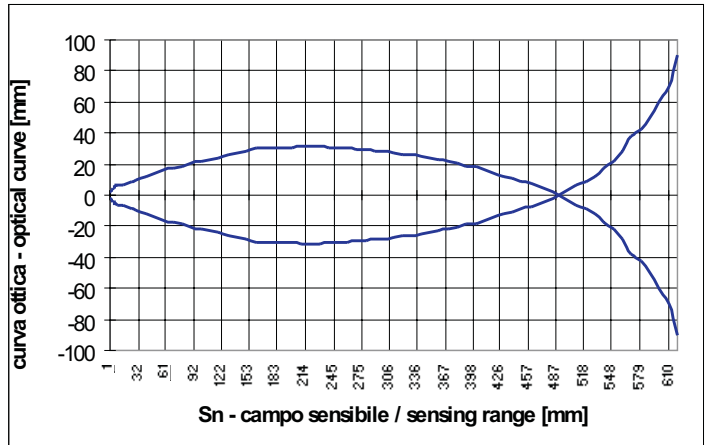
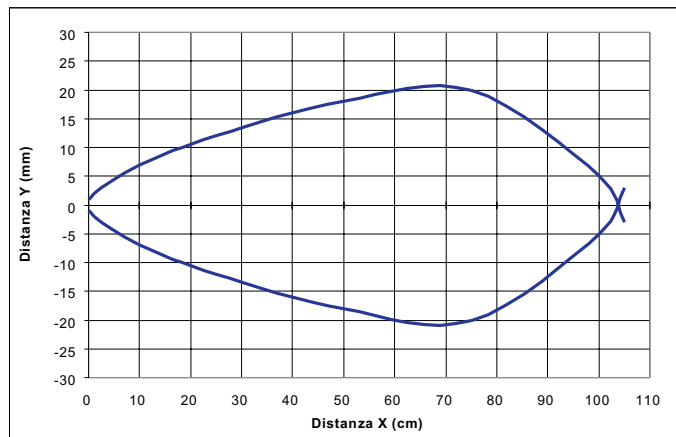
**MODELLO D, DA TYPE
MODELLO K/D, K/DA TYPE**

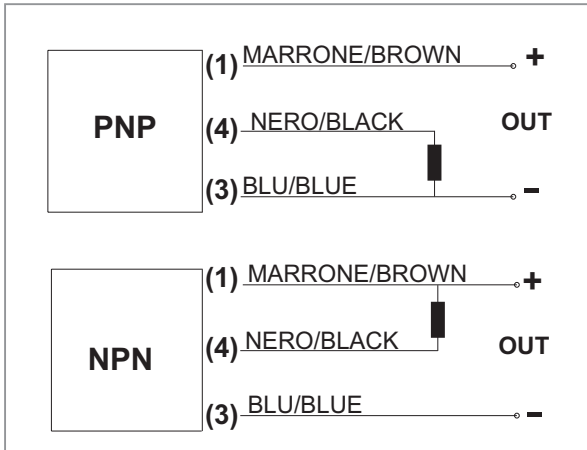
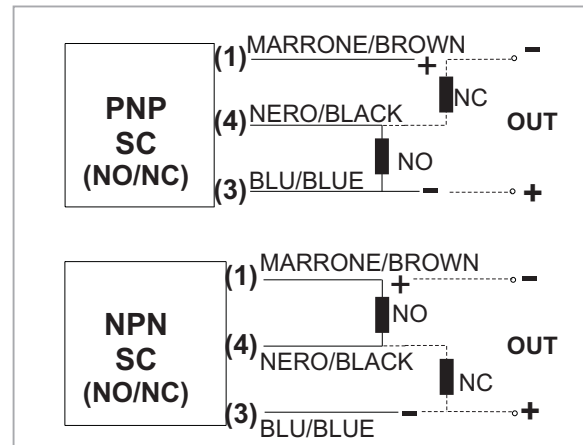
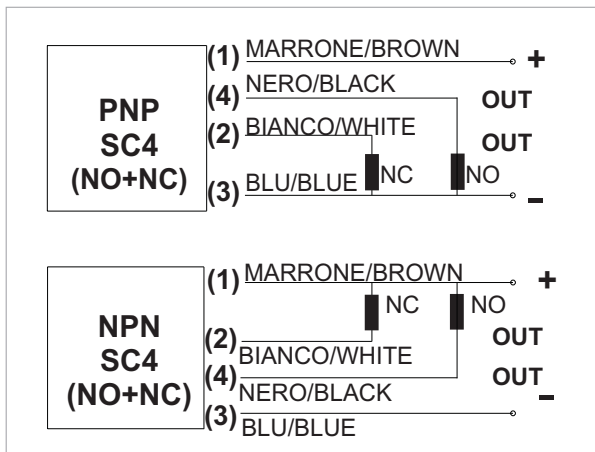
**MODELLO D1, D1A TYPE
MODELLO K/D1, K/D1A TYPE**

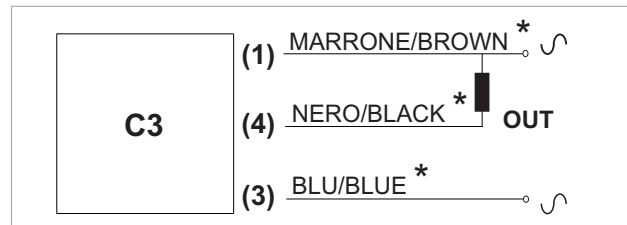
MODELLO D2, D2A TYPE

MODELLO D3, D3A TYPE

MODELLO D4 TYPE

3 FILI C.C. / 3 WIRES D.C.

3 FILI SC (C.C.) / 3 WIRES SC (D.C.)

4 FILI SC (C.C.) / 4 WIRES (D.C.)

**3 FILI C.A. / 3 WIRES (A.C.)
 USCITA CAVO / CABLE OUTPUT**

**3 FILI C.A. / 3 WIRES (A.C.)
 USCITA CONNETTORE / CONNECTOR OUTPUT**

* COLORE FILI DEL CONNETTORE / CONNECTOR WIRE COLOR

TASTEGGIO DIRETTO
DIFFUSE TYPE
ELENCO PRODOTTI
OTTICA ASSIALE / ASSIAL OPTICAL
PRODUCTS LIST
MODELLO D - Sn = 100 mm
D TYPE - Sn = 100 mm

USCITA/OUTPUT	PLASTICA / PLASTIC		METALLICA / METAL	
	CAVO / CABLE	CONNETTORE/CONNECTOR	CAVO / CABLE	CONNETTORE/CONNECTOR
PNP NO	OCV81/DPNO	OCV81/DPNOC5	OCV81/DPNOM	OCV81/DPNOMC5
PNP NC	OCV81/DPNC	OCV81/DPNCC5	OCV81/DPNCM	OCV81/DPNCMC5
PNP SC	OCV81/DPSC	OCV81/DPSCC5	OCV81/DPSCM	OCV81/DPSCMC5
PNP SC4	OCV81/DPSC4	OCV81/DPSC4C5	OCV81/DPSC4M	OCV81/DPSC4MC5
NPN NO	OCV81/DNNO	OCV81/DNNOCC5	OCV81/DNNOM	OCV81/DNNOMC5
NPN NC	OCV81/DNNC	OCV81/DNNC5	OCV81/DNNCM	OCV81/DNNCMC5
NPN SC	OCV81/DNSC	OCV81/DNSCC5	OCV81/DNSCM	OCV81/DNSCMC5
NPN SC4	OCV81/DNSC4	OCV81/DNSC4C5	OCV81/DNSC4M	OCV81/DNSC4MC5
C.A. NO	OCV81/DC3NO	OCV81/DC3NOC5	OCV81/DC3NOM	OCV81/DC3NOMC5
C.A. NC	OCV81/DC3NC	OCV81/DC3NCC5	OCV81/DC3NCM	OCV81/DC3NCMC5

MODELLO D1 - Sn = 200 mm
D1 TYPE - Sn = 200 mm

USCITA/OUTPUT	PLASTICA/PLASTIC		METALLICA/METAL	
	CAVO/CABLE	CONNETTORE/CONNECTOR	CAVO/CABLE	CONNETTORE/CONNECTOR
PNP NO	OCV81/D1PNO	OCV81/D1PNOC5	OCV81/D1PNOM	OCV81/D1PNOMC5
PNP NC	OCV81/D1PNC	OCV81/D1PNCC5	OCV81/D1PNCM	OCV81/D1PNCMC5
PNP SC	OCV81/D1PSC	OCV81/D1PSCC5	OCV81/D1PSCM	OCV81/D1PSCMC5
PNP SC4	OCV81/D1PSC4	OCV81/D1PSC4C5	OCV81/D1PSC4M	OCV81/D1PSC4MC5
NPN NO	OCV81/D1NNO	OCV81/D1NNOC5	OCV81/D1NNOM	OCV81/D1NNOMC5
NPN NC	OCV81/D1NNC	OCV81/D1NNCC5	OCV81/D1NNCM	OCV81/D1NNCMC5
NPN SC	OCV81/D1NSC	OCV81/D1NSCC5	OCV81/D1NSCM	OCV81/D1NSCMC5
NPN SC4	OCV81/D1NSC4	OCV81/D1NSC4C5	OCV81/D1NSC4M	OCV81/D1NSC4MC5
C.A. NO	OCV81/D1C3NO	OCV81/D1C3NOC5	OCV81/D1C3NOM	OCV81/D1C3NOMC5
C.A. NC	OCV81/D1C3NC	OCV81/D1C3NCC5	OCV81/D1C3NCM	OCV81/D1C3NCMC5

MODELLO D1 - Sn = 200 mm - REGOLABILE
D1 TYPE - Sn = 200 mm - ADJUSTABLE

USCITA/OUTPUT	PLASTICA / PLASTIC		METALLICA / METAL	
	CAVO / CABLE	CONNETTORE/CONNECTOR	CAVO / CABLE	CONNETTORE/CONNECTOR
PNP NO	OCV81/D1PNOR	-	OCV81/D1PNORM	OCV81/D1PNORMC5
PNP NC	OCV81/D1PNCR	-	OCV81/D1PNCRM	OCV81/D1PNCRM5
PNP SC	OCV81/D1PSCR	-	OCV81/D1PSCRM	OCV81/D1PSCRM5
PNP SC4	OCV81/D1PSC4R	-	OCV81/D1PSC4RM	OCV81/D1PSC4RM5
NPN NO	OCV81/D1NNOR	-	OCV81/D1NNORM	OCV81/D1NNORMC5
NPN NC	OCV81/D1NNCR	-	OCV81/D1NNCRM	OCV81/D1NNCRM5
NPN SC	OCV81/D1NSCR	-	OCV81/D1NSCRM	OCV81/D1NSCRM5
NPN SC4	OCV81/D1NSC4R	-	OCV81/D1NSC4RM	OCV81/D1NSC4RM5
C.A. NO	OCV81/D1C3NOR	-	OCV81/D1C3NORM	OCV81/D1C3NORMC5
C.A. NC	OCV81/D1C3NCR	-	OCV81/D1C3NCRM	OCV81/D1C3NCRM5

MODELLO D2 - Sn = 400 mm
D2 TYPE - Sn = 400 mm

USCITA/OUTPUT	PLASTICA/PLASTIC		METALLICA/METAL	
	CAVO/CABLE	CONNETTORE/CONNECTOR	CAVO/CABLE	CONNETTORE/CONNECTOR
PNP NO	OCV81/D2PNO	OCV81/D2PNOC5	OCV81/D2PNOM	OCV81/D2PNOMC5
PNP NC	OCV81/D2PNC	OCV81/D2PNCC5	OCV81/D2PNCM	OCV81/D2PNCMC5
PNP SC	OCV81/D2PSC	OCV81/D2PSCC5	OCV81/D2PSCM	OCV81/D2PSCMC5
PNP SC4	OCV81/D2PSC4	OCV81/D2PSC4C5	OCV81/D2PSC4M	OCV81/D2PSC4MC5
NPN NO	OCV81/D2NNO	OCV81/D2NNOC5	OCV81/D2NNOM	OCV81/D2NNOMC5
NPN NC	OCV81/D2NNC	OCV81/D2NNCC5	OCV81/D2NNCM	OCV81/D2NNCMC5
NPN SC	OCV81/D2NSC	OCV81/D2NSCC5	OCV81/D2NSCM	OCV81/D2NSCMC5
NPN SC4	OCV81/D2NSC4	OCV81/D2NSC4C5	OCV81/D2NSC4M	OCV81/D2NSC4MC5
C.A. NO	OCV81/D2C3NO	OCV81/D2C3NOC5	OCV81/D2C3NOM	OCV81/D2C3NOMC5
C.A. NC	OCV81/D2C3NC	OCV81/D2C3NCC5	OCV81/D2C3NCM	OCV81/D2C3NCMC5

MODELLO D2 - Sn = 400 mm - REGOLABILE
D2 TYPE - Sn = 400 mm ADJUSTABLE

USCITA/OUTPUT	PLASTICA / PLASTIC		METALLICA / METAL	
	CAVO/CABLE	CONNETTORE/CONNECTOR	CAVO/CABLE	CONNETTORE/CONNECTOR
PNP NO	OCV81/D2PNOR	-	OCV81/D2PNORM	OCV81/D2PNORMC5
PNP NC	OCV81/D2PNCR	-	OCV81/D2PNCRM	OCV81/D2PNCRM5
PNP SC	OCV81/D2PSCR	-	OCV81/D2PSCRM	OCV81/D2PSCRM5
PNP SC4	OCV81/D2PSC4R	-	OCV81/D2PSC4RM	OCV81/D2PSC4RM5
NPN NO	OCV81/D2NNOR	-	OCV81/D2NNORM	OCV81/D2NNORMC5
NPN NC	OCV81/D2NNCR	-	OCV81/D2NNCRM	OCV81/D2NNCRM5
NPN SC	OCV81/D2NSCR	-	OCV81/D2NSCRM	OCV81/D2NSCRM5
NPN SC4	OCV81/D2NSC4R	-	OCV81/D2NSC4RM	OCV81/D2NSC4RM5
C.A. NO	OCV81/D2C3NOR	-	OCV81/D2C3NORM	OCV81/D2C3NORMC5
C.A. NC	OCV81/D2C3NCR	-	OCV81/D2C3NCRM	OCV81/D2C3NCRM5

MODELLO D3 - Sn = 600 mm
D3 TYPE - Sn = 600 mm

USCITA/OUTPUT	PLASTICA / PLASTIC		METALLICA / METAL	
	CAVO/CABLE	CONNETTORE/CONNECTOR	CAVO/CABLE	CONNETTORE/CONNECTOR
PNP NO	OCV81/D3PNO	OCV81/D3PNOC5	OCV81/D3PNOM	OCV81/D3PNOMC5
PNP NC	OCV81/D3PNC	OCV81/D3PNCC5	OCV81/D3PNCM	OCV81/D3PNCMC5
PNP SC	OCV81/D3PSC	OCV81/D3PSCC5	OCV81/D3PSCM	OCV81/D3PSCMC5
PNP SC4	OCV81/D3PSC4	OCV81/D3PSC4C5	OCV81/D3PSC4M	OCV81/D3PSC4MC5
NPN NO	OCV81/D3NNO	OCV81/D3NNOC5	OCV81/D3NNOM	OCV81/D3NNOMC5
NPN NC	OCV81/D3NNC	OCV81/D3NNCC5	OCV81/D3NNCM	OCV81/D3NNCMC5
NPN SC	OCV81/D3NSC	OCV81/D3NSCC5	OCV81/D3NSCM	OCV81/D3NSCMC5
NPN SC4	OCV81/D3NSC4	OCV81/D3NSC4C5	OCV81/D3NSC4M	OCV81/D3NSC4MC5

MODELLO D3 - Sn = 600 mm - REGOLABILE
D3 TYPE - Sn = 600 mm ADJUSTABLE

USCITA/OUTPUT	PLASTICA / PLASTIC		METALLICA / METAL	
	CAVO / CABLE	CONNETTORE / CONNECTOR	CAVO / CABLE	CONNETTORE / CONNECTOR
PNP NO	OCV81/D3PNOR	-	OCV81/D3PNORM	OCV81/D3PNORMC5
PNP NC	OCV81/D3PNCR	-	OCV81/D3PNCRM	OCV81/D3PNCRM5
PNP SC	OCV81/D3PSCR	-	OCV81/D3PSCRM	OCV81/D3PSCRM5
PNP SC4	OCV81/D3PSC4R	-	OCV81/D3PSC4RM	OCV81/D3PSC4RM5
NPN NO	OCV81/D3NNOR	-	OCV81/D3NNORM	OCV81/D3NNORMC5
NPN NC	OCV81/D3NNCR	-	OCV81/D3NNCRM	OCV81/D3NNCRM5
NPN SC	OCV81/D3NSCR	-	OCV81/D3NSCRM	OCV81/D3NSCRM5
NPN SC4	OCV81/D3NSC4R	-	OCV81/D3NSC4RM	OCV81/D3NSC4RM5

MODELLO D4 - Sn = 1000 mm
D4 TYPE - Sn = 1000 mm

USCITA/OUTPUT	PLASTICA / PLASTIC		METALLICA / METAL	
	CAVO / CABLE	CONNETTORE / CONNECTOR	CAVO / CABLE	CONNETTORE / CONNECTOR
PNP NO	OCV81/D4PNO	OCV81/D4PNO5	OCV81/D4PNOM	OCV81/D4PNOMC5
PNP NC	OCV81/D4PNC	OCV81/D4PNCC5	OCV81/D4PNCM	OCV81/D4PNCMC5
PNP SC	OCV81/D4PSC	OCV81/D4PSCC5	OCV81/D4PSCM	OCV81/D4PSCMC5
PNP SC4	OCV81/D4PSC4	OCV81/D4PSC4C5	OCV81/D4PSC4M	OCV81/D4PSC4MC5
NPN NO	OCV81/D4NNO	OCV81/D4NNOC5	OCV81/D4NNOM	OCV81/D4NNOMC5
NPN NC	OCV81/D4NNC	OCV81/D4NNCC5	OCV81/D4NNCM	OCV81/D4NNCMC5
NPN SC	OCV81/D4NSC	OCV81/D4NSCC5	OCV81/D4NSCM	OCV81/D4NSCMC5
NPN SC4	OCV81/D4NSC4	OCV81/D4NSC4C5	OCV81/D4NSC4M	OCV81/D4NSC4MC5

MODELLO D4 - Sn = 1000 mm - REGOLABILE
D4 TYPE - Sn = 1000 mm - ADJUSTABLE

USCITA/OUTPUT	PLASTICA / PLASTIC		METALLICA / METAL	
	CAVO / CABLE	CONNETTORE / CONNECTOR	CAVO / CABLE	CONNETTORE / CONNECTOR
PNP NO	OCV81/D4PNOR	-	OCV81/D4PNORM	OCV81/D4PNORMC5
PNP NC	OCV81/D4PNCR	-	OCV81/D4PNCRM	OCV81/D4PNCRM5
PNP SC	OCV81/D4PSCR	-	OCV81/D4PSCRM	OCV81/D4PSCRM5
PNP SC4	OCV81/D4PSC4R	-	OCV81/D4PSC4RM	OCV81/D4PSC4RM5
NPN NO	OCV81/D4NNOR	-	OCV81/D4NNORM	OCV81/D4NNORMC5
NPN NC	OCV81/D4NNCR	-	OCV81/D4NNCRM	OCV81/D4NNCRM5
NPN SC	OCV81/D4NSCR	-	OCV81/D4NSCRM	OCV81/D4NSCRM5
NPN SC4	OCV81/D4NSC4R	-	OCV81/D4NSC4RM	OCV81/D4NSC4RM5

TASTEGGIO DIRETTO RADIALE
RADIAL DIFFUSE TYPE
ELENCO PRODOTTI
OTTICA RADIALE/ RADIAL OPTICAL
PRODUCTS LIST
MODELLO D - Sn = 100 mm
D TYPE - Sn = 100 mm

USCITA/OUTPUT	PLASTICA / PLASTIC		METALLICA / METAL	
	CAVO / CABLE	CONNETTORE/CONNECTOR	CAVO / CABLE	CONNETTORE/CONNECTOR
PNP NO	OCV81/DAPNO	OCV81/DAPNOC5	OCV81/DAPNOM	OCV81/DAPNOMC5
PNP NC	OCV81/DAPNC	OCV81/DAPNCC5	OCV81/DAPNCM	OCV81/DAPNCMC5
PNP SC	OCV81/DAPSC	OCV81/DAPSCC5	OCV81/DAPSCM	OCV81/DAPSCMC5
PNP SC4	OCV81/DAPSC4	OCV81/DAPSC4C5	OCV81/DAPSC4M	OCV81/DAPSC4MC5
NPN NO	OCV81/DANNO	OCV81/DANNOC5	OCV81/DANNOM	OCV81/DANNOMC5
NPN NC	OCV81/DANNC	OCV81/DANNCC5	OCV81/DANNCM	OCV81/DANNCMC5
NPN SC	OCV81/DANSC	OCV81/DANSCC5	OCV81/DANSCM	OCV81/DANSCMC5
NPN SC4	OCV81/DANSC4	OCV81/DANSC4C5	OCV81/DANSC4M	OCV81/DANSC4MC5
C.A. NO	OCV81/DAC3NO	OCV81/DAC3NOC5	OCV81/DAC3NOM	OCV81/DAC3NOMC5
C.A. NC	OCV81/DAC3NC	OCV81/DAC3NCC5	OCV81/DAC3NCM	OCV81/DAC3NCMC5

MODELLO D1 - Sn = 200 mm
D1 TYPE - Sn = 200 mm

USCITA/OUTPUT	PLASTICA/PLASTIC		METALLICA/METAL	
	CAVO/CABLE	CONNETTORE/CONNECTOR	CAVO/CABLE	CONNETTORE/CONNECTOR
PNP NO	OCV81/D1APNO	OCV81/D1APNOC5	OCV81/D1APNOM	OCV81/D1APNOMC5
PNP NC	OCV81/D1APNC	OCV81/D1APNCC5	OCV81/D1APNCM	OCV81/D1APNCMC5
PNP SC	OCV81/D1APSC	OCV81/D1APSCC5	OCV81/D1APSCM	OCV81/D1APSCMC5
PNP SC4	OCV81/D1APSC4	OCV81/D1APSC4C5	OCV81/D1APSC4M	OCV81/D1APSC4MC5
NPN NO	OCV81/D1ANNO	OCV81/D1ANNOC5	OCV81/D1ANNOM	OCV81/D1ANNOMC5
NPN NC	OCV81/D1ANNC	OCV81/D1ANNCC5	OCV81/D1ANNCM	OCV81/D1ANNCMC5
NPN SC	OCV81/D1ANSC	OCV81/D1ANSCC5	OCV81/D1ANSCM	OCV81/D1ANSCMC5
NPN SC4	OCV81/D1ANSC4	OCV81/D1ANSC4C5	OCV81/D1ANSC4M	OCV81/D1ANSC4MC5
C.A. NO	OCV81/D1AC3NO	OCV81/D1AC3NOC5	OCV81/D1AC3NOM	OCV81/D1AC3NOMC5
C.A. NC	OCV81/D1AC3NC	OCV81/D1AC3NCC5	OCV81/D1AC3NCM	OCV81/D1AC3NCMC5

MODELLO D1 - Sn = 200 mm - REGOLABILE
D1 TYPE - Sn = 200 mm - ADJUSTABLE

USCITA/OUTPUT	PLASTICA / PLASTIC		METALLICA / METAL	
	CAVO/CABLE	CONNETTORE/CONNECTOR	CAVO/CABLE	CONNETTORE/CONNECTOR
PNP NO	OCV81/D1APNOR	-	OCV81/D1APNORM	OCV81/D1APNORMC5
PNP NC	OCV81/D1APNCR	-	OCV81/D1APNCRM	OCV81/D1APNCRM5
PNP SC	OCV81/D1APSCR	-	OCV81/D1APSCRM	OCV81/D1APSCRM5
PNP SC4	OCV81/D1APSC4R	-	OCV81/D1APSC4RM	OCV81/D1APSC4RM5
NPN NO	OCV81/D1ANNOR	-	OCV81/D1ANNORM	OCV81/D1ANNORMC5
NPN NC	OCV81/D1ANNCR	-	OCV81/D1ANNCRM	OCV81/D1ANNCRM5
NPN SC	OCV81/D1ANSCR	-	OCV81/D1ANSCRM	OCV81/D1ANSCRM5
NPN SC4	OCV81/D1ANSC4R	-	OCV81/D1ANSC4RM	OCV81/D1ANSC4RM5
C.A. NO	OCV81/D1AC3NOR	-	OCV81/D1AC3NORM	OCV81/D1AC3NORMC5
C.A. NC	OCV81/D1AC3NCR	-	OCV81/D1AC3NCRM	OCV81/D1AC3NCRM5

MODELLO D2 - Sn = 400 mm
D2 TYPE - Sn = 400 mm

USCITA/OUTPUT	PLASTICA/PLASTIC		METALLICA/METAL	
	CAVO/CABLE	CONNETTORE/CONNECTOR	CAVO/CABLE	CONNETTORE/CONNECTOR
PNP NO	OCV81/D2APNO	OCV81/D2APNOC5	OCV81/D2APNOM	OCV81/D2APNOMC5
PNP NC	OCV81/D2APNC	OCV81/D2APNCC5	OCV81/D2APNCM	OCV81/D2APNCMC5
PNP SC	OCV81/D2APSC	OCV81/D2APSCC5	OCV81/D2APSCM	OCV81/D2APSCMC5
PNP SC4	OCV81/D2APSC4	OCV81/D2APSC4C5	OCV81/D2APSC4M	OCV81/D2APSC4MC5
NPN NO	OCV81/D2ANNO	OCV81/D2ANNOC5	OCV81/D2ANNOM	OCV81/D2ANNOMC5
NPN NC	OCV81/D2ANNC	OCV81/D2ANNCC5	OCV81/D2ANNCM	OCV81/D2ANNCMC5
NPN SC	OCV81/D2ANSC	OCV81/D2ANSCC5	OCV81/D2ANSCM	OCV81/D2ANSCMC5
NPN SC4	OCV81/D2ANSC4	OCV81/D2ANSC4C5	OCV81/D2ANSC4M	OCV81/D2ANSC4MC5
C.A. NO	OCV81/D2AC3NO	OCV81/D2AC3NOC5	OCV81/D2AC3NOM	OCV81/D2AC3NOMC5
C.A. NC	OCV81/D2AC3NC	OCV81/D2AC3NCC5	OCV81/D2AC3NCM	OCV81/D2AC3NCMC5

MODELLO D2 - Sn = 400 mm - REGOLABILE
D2 TYPE - Sn = 400 mm ADJUSTABLE

USCITA/OUTPUT	PLASTICA /PLASTIC		METALLICA /METAL	
	CAVO/CABLE	CONNETTORE/CONNECTOR	CAVO/CABLE	CONNETTORE/CONNECTOR
PNP NO	OCV81/D2APNOR	-	OCV81/D2APNORM	OCV81/D2APNORMC5
PNP NC	OCV81/D2APNCR	-	OCV81/D2APNCRM	OCV81/D2APNCRM5
PNP SC	OCV81/D2APSCR	-	OCV81/D2APSCRM	OCV81/D2APSCRM5
PNP SC4	OCV81/D2APSC4R	-	OCV81/D2APSC4RM	OCV81/D2APSC4RM5
NPN NO	OCV81/D2ANNOR	-	OCV81/D2ANNORM	OCV81/D2ANNORMC5
NPN NC	OCV81/D2ANNCR	-	OCV81/D2ANNCRM	OCV81/D2ANNCRM5
NPN SC	OCV81/D2ANSCR	-	OCV81/D2ANSCRM	OCV81/D2ANSCRM5
NPN SC4	OCV81/D2ANSC4R	-	OCV81/D2ANSC4RM	OCV81/D2ANSC4RM5
C.A. NO	OCV81/D2AC3NOR	-	OCV81/D2AC3NORM	OCV81/D2AC3NORMC5
C.A. NC	OCV81/D2AC3NCR	-	OCV81/D2AC3NCRM	OCV81/D2AC3NCRM5

MODELLO D3 - Sn = 600 mm
D3 TYPE - Sn = 600 mm

USCITA/OUTPUT	PLASTICA / PLASTIC		METALLICA / METAL	
	CAVO/CABLE	CONNETTORE/CONNECTOR	CAVO/CABLE	CONNETTORE/CONNECTOR
PNP NO	OCV81/D3APNO	OCV81/D3APNOC5	OCV81/D3APNOM	OCV81/D3APNOMC5
PNP NC	OCV81/D3APNC	OCV81/D3APNCC5	OCV81/D3APNCM	OCV81/D3APNCMC5
PNP SC	OCV81/D3APSC	OCV81/D3APSCC5	OCV81/D3APSCM	OCV81/D3APSCMC5
PNP SC4	OCV81/D3APSC4	OCV81/D3APSC4C5	OCV81/D3APSC4M	OCV81/D3APSC4MC5
NPN NO	OCV81/D3ANNO	OCV81/D3ANNOC5	OCV81/D3ANNOM	OCV81/D3ANNOMC5
NPN NC	OCV81/D3ANNC	OCV81/D3ANNCC5	OCV81/D3ANNCM	OCV81/D3ANNCMC5
NPN SC	OCV81/D3ANSC	OCV81/D3ANSCC5	OCV81/D3ANSCM	OCV81/D3ANSCMC5
NPN SC4	OCV81/D3ANSC4	OCV81/D3ANSC4C5	OCV81/D3ANSC4M	OCV81/D3ANSC4MC5

MODELLO D3 - Sn = 600 mm - REGOLABILE
D3 TYPE - Sn = 600 mm ADJUSTABLE

USCITA/OUTPUT	PLASTICA / PLASTIC		METALLICA / METAL	
	CAVO/CABLE	CONNETTORE/CONNECTOR	CAVO/CABLE	CONNETTORE/CONNECTOR
PNP NO	OCV81/D3APNOR	-	OCV81/D3APNORM	OCV81/D3APNORMC5
PNP NC	OCV81/D3APNCR	-	OCV81/D3APNCRM	OCV81/D3APNCRM5
PNP SC	OCV81/D3APSCR	-	OCV81/D3APSCRM	OCV81/D3APSCRM5
PNP SC4	OCV81/D3APSC4R	-	OCV81/D3APSC4RM	OCV81/D3APSC4RM5
NPN NO	OCV81/D3ANNOR	-	OCV81/D3ANNORM	OCV81/D3ANNORM5
NPN NC	OCV81/D3ANNCR	-	OCV81/D3ANNCRM	OCV81/D3ANNCRM5
NPN SC	OCV81/D3ANSCR	-	OCV81/D3ANSCRM	OCV81/D3ANSCRM5
NPN SC4	OCV81/D3ANSC4R	-	OCV81/D3ANSC4RM	OCV81/D3ANSC4RM5

TASTEGGIO
ALTE FREQUENZE 10 kHz

DIFFUSE TYPE
10 kHz WORKING FREQUENCY

ELENCO PRODOTTI
ALTE FREQUENZE 10 kHz / 10 kHz HIGH FREQUENCY
PRODUCTS LIST
MODELLO D - Sn = 100 mm
D TYPE - Sn = 100 mm

USCITA/OUTPUT	PLASTICA / PLASTIC		METALLICA / METAL	
	CAVO / CABLE	CONNETTORE/CONNECTOR	CAVO / CABLE	CONNETTORE/CONNECTOR
PNP NO	OCV81K/DPNO	OCV81K/DPNOC5	OCV81K/DPNOM	OCV81K/DPNOMC5
PNP NC	OCV81K/DPNC	OCV81K/DPNCC5	OCV81K/DPNCM	OCV81K/DPNCMC5
NPN NO	OCV81K/DNNO	OCV81K/DNNOC5	OCV81K/DNNOM	OCV81K/DNNOMC5
NPN NC	OCV81K/DNNC	OCV81K/DNNCC5	OCV81K/DNNCM	OCV81K/DNNCMC5

MODELLO D1 - Sn = 200 mm
D1 TYPE - Sn = 200 mm

USCITA/OUTPUT	PLASTICA / PLASTIC		METALLICA / METAL	
	CAVO/CABLE	CONNETTORE/CONNECTOR	CAVO/CABLE	CONNETTORE/CONNECTOR
PNP NO	OCV81K/D1PNO	OCV81K/D1PNOC5	OCV81K/D1PNOM	OCV81K/D1PNOMC5
PNP NC	OCV81K/D1PNC	OCV81K/D1PNCC5	OCV81K/D1PNCM	OCV81K/D1PNCMC5
NPN NO	OCV81K/D1NNO	OCV81K/D1NNOC5	OCV81K/D1NNOM	OCV81K/D1NNOMC5
NPN NC	OCV81K/D1NNC	OCV81K/D1NNCC5	OCV81K/D1NNCM	OCV81K/D1NNCMC5

MODELLO D1 - Sn = 200 mm - REGOLABILE
D1 TYPE - Sn = 200 mm - ADJUSTABLE

USCITA/OUTPUT	PLASTICA / PLASTIC		METALLICA / METAL	
	CAVO/CABLE	CONNETTORE/CONNECTOR	CAVO/CABLE	CONNETTORE/CONNECTOR
PNP NO	OCV81K/D1PNOR	-	OCV81K/D1PNORM	OCV81K/D1PNORMC5
PNP NC	OCV81K/D1PNCR	-	OCV81K/D1PNCRM	OCV81K/D1PNCRM5
NPN NO	OCV81K/D1NNOR	-	OCV81K/D1NNORM	OCV81K/D1NNORMC5
NPN NC	OCV81K/D1NNCR	-	OCV81K/D1NNCRM	OCV81K/D1NNCRM5

**TASTEGGIO RADIALE
ALTE FREQUENZE 10 kHz**
**RADIAL DIFFUSE TYPE
10 kHz WORKING FREQUENCY**
**ELENCO PRODOTTI ALTE FREQUENZE 10 kHz / 10 kHz HIGH FREQUENCY PRODUCTS LIST
OTTICA RADIALE / RADIAL OPTICAL**
MODELLO D - Sn = 100 mm
D TYPE - Sn = 100 mm

USCITA/OUTPUT	PLASTICA / PLASTIC		METALLICA / METAL	
	CAVO / CABLE	CONNETTORE/CONNECTOR	CAVO / CABLE	CONNETTORE/CONNECTOR
PNP NO	OCV81K/DAPNO	OCV81K/DAPNOC5	OCV81K/DAPNOM	OCV81K/DAPNOMC5
PNP NC	OCV81K/DAPNC	OCV81K/DAPNCC5	OCV81K/DAPNCM	OCV81K/DAPNCMC5
NPN NO	OCV81K/DANNO	OCV81K/DANNOC5	OCV81K/DANNOM	OCV81K/DANNOMC5
NPN NC	OCV81K/DANNC	OCV81K/DANNCC5	OCV81K/DANNCM	OCV81K/DANNCMC5

MODELLO D1 - Sn = 200 mm
D1 TYPE - Sn = 200 mm

USCITA/OUTPUT	PLASTICA/PLASTIC		METALLICA/METAL	
	CAVO/CABLE	CONNETTORE/CONNECTOR	CAVO/CABLE	CONNETTORE/CONNECTOR
PNP NO	OCV81K/D1APNO	OCV81K/D1APNOC5	OCV81K/D1APNOM	OCV81K/D1APNOMC5
PNP NC	OCV81K/D1APNC	OCV81K/D1APNCC5	OCV81K/D1APNCM	OCV81K/D1APNCMC5
NPN NO	OCV81K/D1ANNO	OCV81K/D1ANNOC5	OCV81K/D1ANNOM	OCV81K/D1ANNOMC5
NPN NC	OCV81K/D1ANNC	OCV81K/D1ANNCC5	OCV81K/D1ANNCM	OCV81K/D1ANNCMC5

MODELLO D1 - Sn = 200 mm - REGOLABILE
D1 TYPE - Sn = 200 mm - ADJUSTABLE

USCITA/OUTPUT	PLASTICA / PLASTIC		METALLICA / METAL	
	CAVO/CABLE	CONNETTORE/CONNECTOR	CAVO/CABLE	CONNETTORE/CONNECTOR
PNP NO	OCV81K/D1APNOR	-	OCV81K/D1APNORM	OCV81K/D1APNORMC5
PNP NC	OCV81K/D1APNCR	-	OCV81K/D1APNCRM	OCV81K/D1APNCRM5
NPN NO	OCV81K/D1ANNOR	-	OCV81K/D1ANNORM	OCV81K/D1ANNORMC5
NPN NC	OCV81K/D1ANNCR	-	OCV81K/D1ANNCRM	OCV81K/D1ANNCRM5

RIFERIMENTI CONNETTORI PARTE VOLANTE
CONNECTOR LOOSE PART CODES

FEMMINA / FEMALE	DIRITTO/STRAIGHT	90° / DEGREES ANGLED CABLE OUTPUT	M12
CABLE / CABLE	L70500	C70500	3 POLI / 3 POLES
CEI 20-22 II - L= 5 m	L90500	C90500	4 POLI / 4 POLES

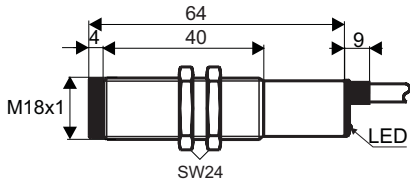
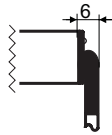
TASTEGGIO DIRETTO
DIFFUSE TYPE
DIMENSIONI MECCANICHE
OTTICA ASSIALE / ASSIAL OPTICAL
MECHANICAL SIZE
CONTENITORE METALLICO / METAL BODY
CONTENITORE PLASTICO / PLASTIC BODY
VERSIONE NON REGOLABILE
FIXED VERSION

 USCITA CAVO 90°
90 DEGREES ANGLED
CABLE OUTPUT

 VISTA PARTE SENSIBILE
SENSITIVE SIDE VIEW

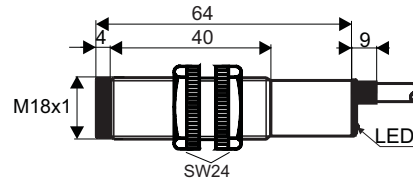
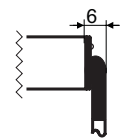
 VISTA USCITA CAVO
CABLE OUTPUT VIEW

 VISTA USCITA CAVO 90°
90 DEGREES ANGLED
CABLE OUTPUT VIEW

VERSIONE NON REGOLABILE
FIXED VERSION

 USCITA CAVO 90°
90 DEGREES ANGLED
CABLE OUTPUT

 VISTA PARTE SENSIBILE
SENSITIVE SIDE VIEW

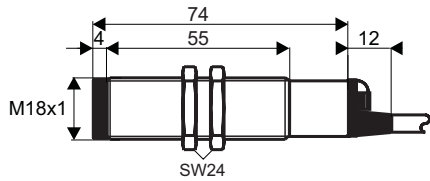
 VISTA USCITA CAVO
CABLE OUTPUT VIEW

 VISTA USCITA CAVO 90°
90 DEGREES ANGLED
CABLE OUTPUT VIEW

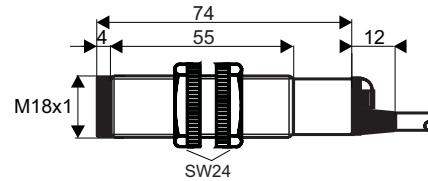
VERSIONE REGOLABILE
ADJUSTABLE VERSION

 VISTA PARTE SENSIBILE
SENSITIVE SIDE VIEW

 VISTA USCITA CAVO
CABLE OUTPUT VIEW

VERSIONE REGOLABILE
ADJUSTABLE VERSION

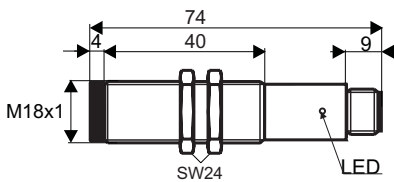
 VISTA PARTE SENSIBILE
SENSITIVE SIDE VIEW

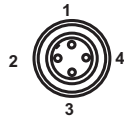
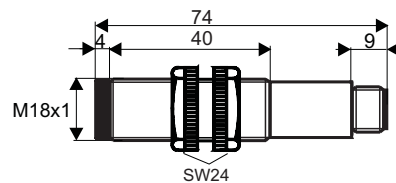
 VISTA USCITA CAVO
CABLE OUTPUT VIEW

VERSIONE NON REGOLABILE
FIXED VERSION

 VISTA PARTE SENSIBILE
SENSITIVE SIDE VIEW

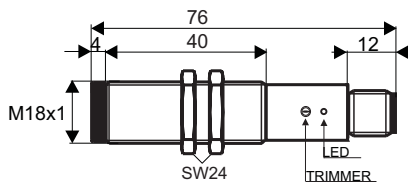
 VISTA USCITA CONNETTORE M12
M12 CONNECTOR OUTPUT VIEW

VERSIONE NON REGOLABILE
FIXED VERSION

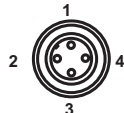
 VISTA PARTE SENSIBILE
SENSITIVE SIDE VIEW

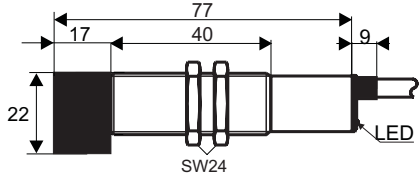
 VISTA USCITA CONNETTORE M12
M12 CONNECTOR OUTPUT VIEW

VERSIONE REGOLABILE
ADJUSTABLE VERSION

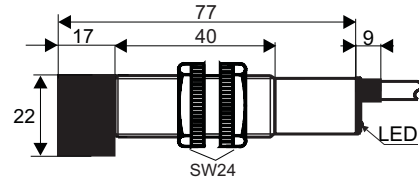
 VISTA PARTE SENSIBILE
SENSITIVE SIDE VIEW

 VISTA USCITA CONNETTORE M12
M12 CONNECTOR OUTPUT VIEW

TASTEGGIO DIRETTO RADIALE
RADIAL DIFFUSE TYPE
DIMENSIONI MECCANICHE
OTTICA RADIALE/ RADIAL OPTICAL
MECHANICAL SIZE
CONTENITORE METALLICO / METAL BODY
CONTENITORE PLASTICO / PLASTIC BODY
VERSIONE NON REGOLABILE
FIXED VERSION

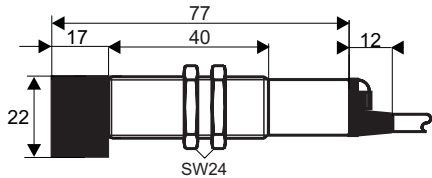
VISTA PARTE SENSIBILE
SENSITIVE SIDE VIEW
VISTA USCITA CAVO
CABLE OUTPUT VIEW

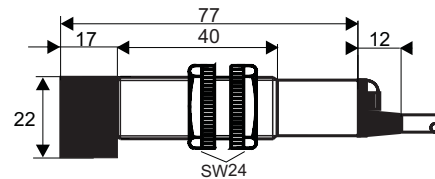
VERSIONE NON REGOLABILE
FIXED VERSION

VISTA PARTE SENSIBILE
SENSITIVE SIDE VIEW
VISTA USCITA CAVO
CABLE OUTPUT VIEW

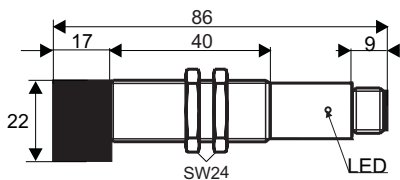
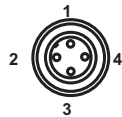
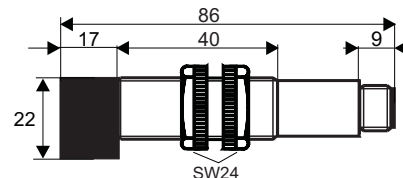
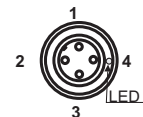
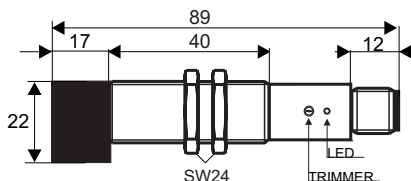
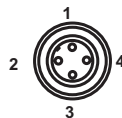
VERSIONE REGOLABILE
ADJUSTABLE VERSION

VISTA PARTE SENSIBILE
SENSITIVE SIDE VIEW
VISTA USCITA CAVO
CABLE OUTPUT VIEW

VERSIONE REGOLABILE
ADJUSTABLE VERSION

VISTA PARTE SENSIBILE
SENSITIVE SIDE VIEW
VISTA USCITA CAVO
CABLE OUTPUT VIEW

VERSIONE NON REGOLABILE
FIXED VERSION

VISTA PARTE SENSIBILE
SENSITIVE SIDE VIEW
VISTA USCITA CONNETTORE M12
M12 CONNECTOR OUTPUT VIEW

VERSIONE NON REGOLABILE
FIXED VERSION

VISTA PARTE SENSIBILE
SENSITIVE SIDE VIEW
VISTA USCITA CONNETTORE M12
M12 CONNECTOR OUTPUT VIEW

VERSIONE REGOLABILE
ADJUSTABLE VERSION

VISTA PARTE SENSIBILE
SENSITIVE SIDE VIEW
VISTA USCITA CONNETTORE M12
M12 CONNECTOR OUTPUT VIEW

Altri prodotti

- interruttori di prossimità induttivi;
- interruttori di prossimità capacitivi;
- interruttori di prossimità magnetici;
- interruttori di prossimità fotoelettrici;

- connettori e cassette di connessione per sensori;

- encoder incrementali ed assoluti;

- alimentatori / interfacce per sensori;
- alimentatori da rete e da secondario per uso generico;

- voltmetri, amperometri, contagiri, visualizzatori a pannello;
- contaimpulsi mono e bidirezionali, contaproduzione, contagiri;
- termometri e termoregolatori

- schede logiche programmabili per uso OEM;

- pulsanteria e finecorsa meccanici;

Other products:

- *inductive proximity switches;*
- *capacitive proximity switches;*
- *magnetic proximity switches;*
- *photo-electric sensors & proximity switches;*

- *connectors & connection boxes for sensor;*

- *incremental & absolute encoders;*

- *supply units / interfaces for sensors;*
- *power supply units for general purpose;*

- *voltmeters, ammeters, revolution counters, panel displays;*
- *counters mono & bi-directional, timers, revolution counters;*
- *thermometers & temperature controllers;*

- *OEM programmable logic cards;*

- *push-button & mechanical limit switches;*